

# GRANDEUR

INS-VS1

ALL MEASUREMENTS ARE IN MILLIMETRES

MANUFACTURED FROM STAINLESS STEEL

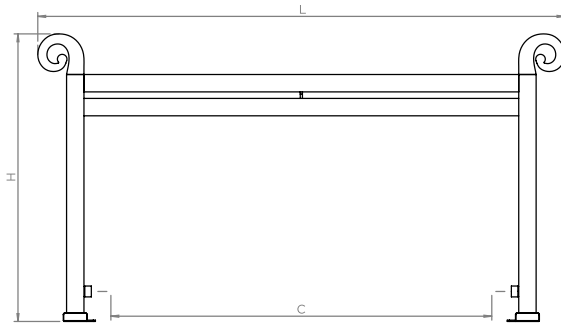
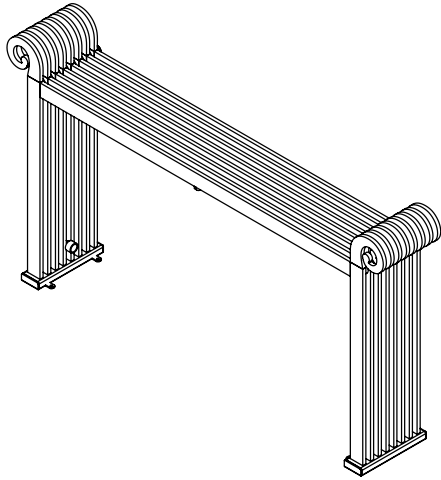

Front View

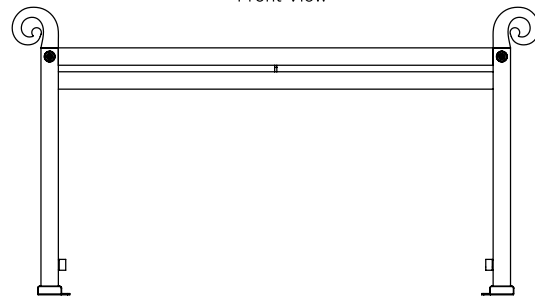

Back View

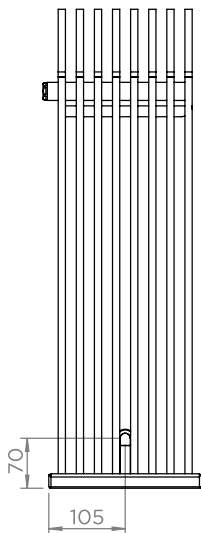

Side View

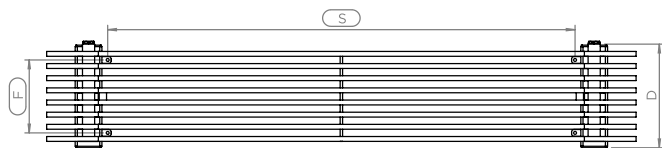

Top View

### Installation Accessories:



x4



x4

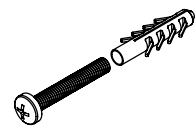

### Plumbing Position:

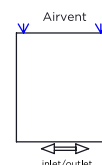

Vertical mount / Free S.  
All Dimensions are in mm  
Max. Working Pressure: 10 Bar  
Max. Working Temperature: 95° C  
Inlet / Outlet : 1/2" BSP  
Fuel : H

Manufacturing Tolerance : - 5 mm

PRODUCT CODE	Height		Length		Depth	Pipe Centres		Bracket Centres	
	H	L	L	L	D	C	F	S	S
	mm	mm	mm	mm	mm	mm	mm	mm	mm
GRA106	660	965	210	630	150	715			
GRA126	660	1215	210	880	150	965			
GRA146	660	1415	210	1080	150	1165			
GRA176	660	1715	210	1380	150	1465			
GRA206	660	2030	210	1695	150	1780			

FR.71-Rev.00

Technical specifications are subject to change without prior notice.

AEON is the designer heating division of Pitacs Limited.  
Pitacs Limited, Bradbourne Point, Bradbourne Drive, Tilbrook, Milton Keynes,  
Buckinghamshire, MK7 8AT, UK

T: +44 (0)1908 271155 E: info@pitacs.com W: www.aeon.uk.com

